

LIDO BLOCK

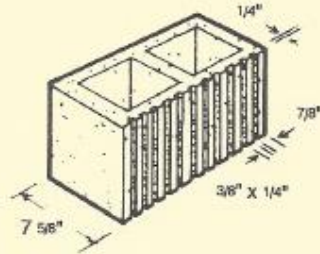

8 x 8 x 16
Lido

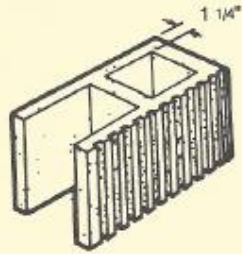
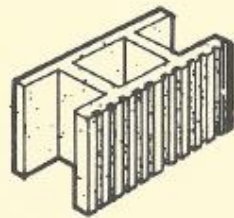

8 x 8 x 16
H Lido Pilaster

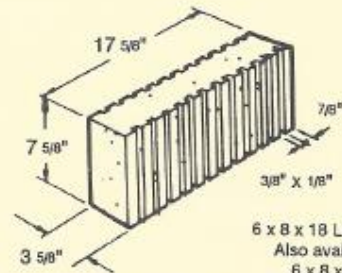

6 x 8 x 18 Lido Cap
Also available
6 x 8 x 18

Lido Block are available scored 2 sides, 2 sides 1 end, 1 side 1 end. The overall dimensions of Lido Block are the same as a standard unit. The scores do not add or take away from these dimensions.

SHADOW BLOCK

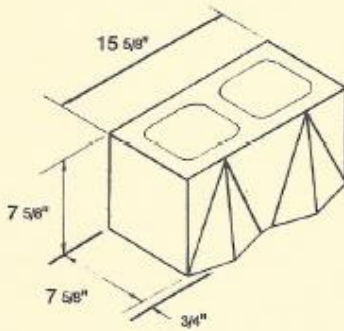

8816 MK II
Also available
As Single Offset Diamond

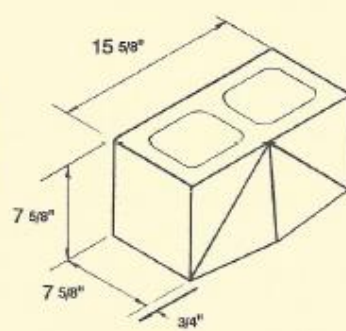

8816 MK I

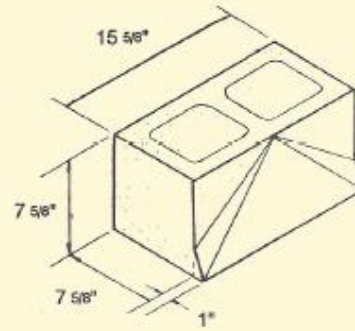

8816
Shadow Block

For exact configurations & dimensions of cores please consult your Architectural Representative.

#503 – 3 VERTICAL SCORES

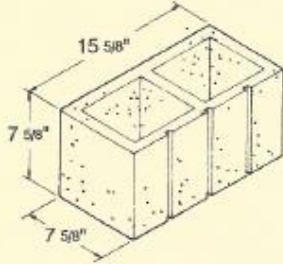

8 x 8 x 16
503 Score

The "503" pattern is manufactured –
 * in 4" and 8" high units
 * in 8" and 12" wide units
 * scored both sides
 * scored one end

#505 – 5 VERTICAL SCORES

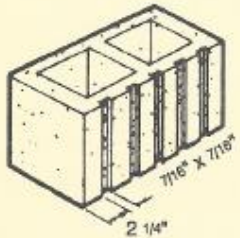

8 x 8 x 16
505 Score

The "505" pattern is manufactured –
 * in 8" high units
 * in 8" and 12" wide units
 * scored both sides

The overall dimension of the 503 and 505 units are the same as standard units. The scores neither add to or take away from these dimensions.

SCREEN BLOCK

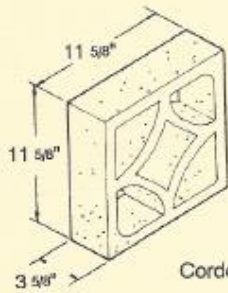

Cordova

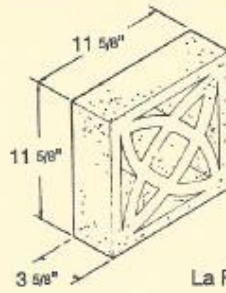

La Fiesta

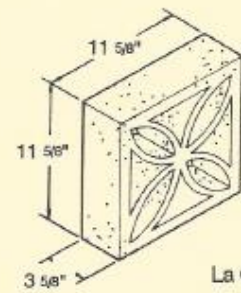

La Costa

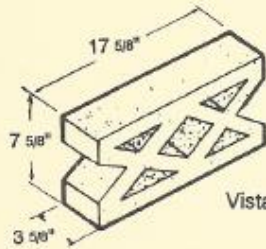

Vista

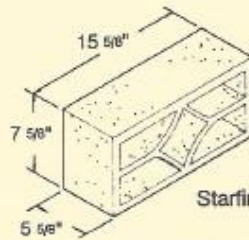

Starfire

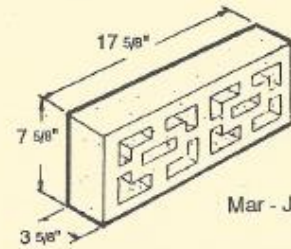

Mar - Jan

For exact configurations & dimensions of cores please consult your Architectural Representative.

8" HIGH BULLNOSE

6" & 8" WIDE

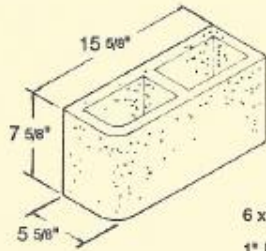

6 x 8 x 16
1" Radius Corners
Bullnose

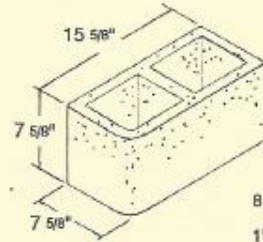

8 x 8 x 16
1" Radius Corners
Bullnose

Radius 2 ends

Bullnose Available As:

Radius 2 sides

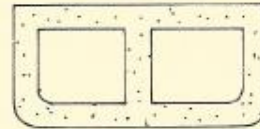
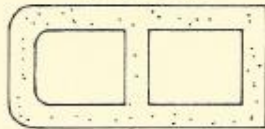

Bullnose Blocks are made on special order only

PRECISION CAPS

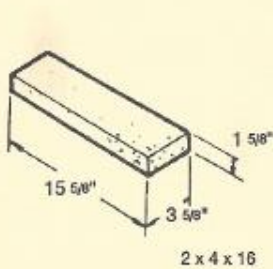

2 x 4 x 16

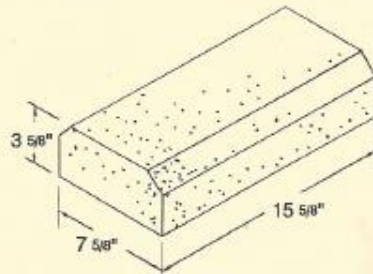

8 x 4 x 16 Beveled Cap



Mushroom Cap

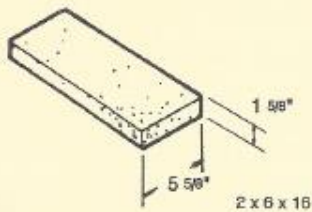

2 x 6 x 16

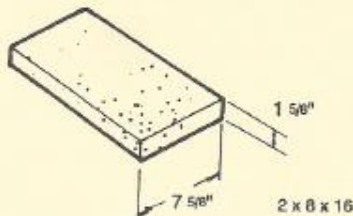

2 x 8 x 16

10 x 4 x 8

For exact configurations & dimensions of cores please consult your Architectural Representative.

MISCELLANEOUS UNITS

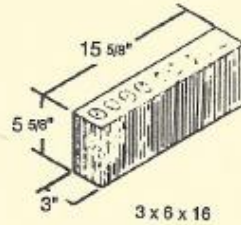
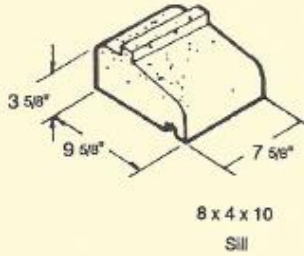

COMBED UNITS

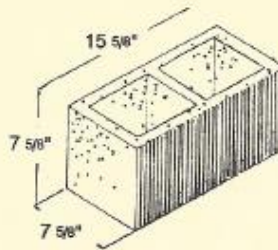

ORCO "Combed" faced units are available in most of the standard sizes.

For exact configurations & dimensions of cores please consult your Architectural Representative.

PRECISION DEEP SCORED UNITS

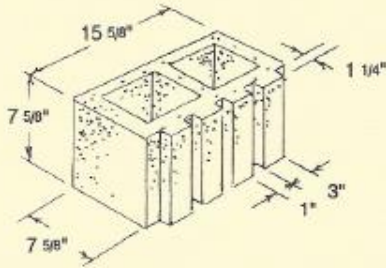

8 x 8 x 16 Scored *301*

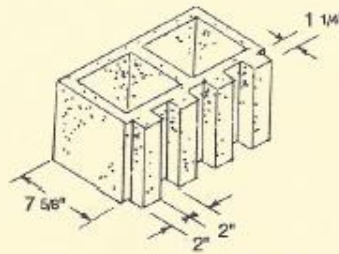

8 x 8 x 16 Scored *202*

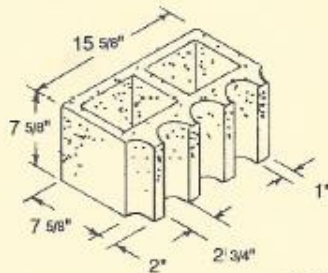

8 x 8 x 16 Fluted *103*

For exact configurations & dimensions of cores please consult your Architectural Representative.

PRECISION RADIUS BLOCK

8" RADIUS – 8 X 8 X 16

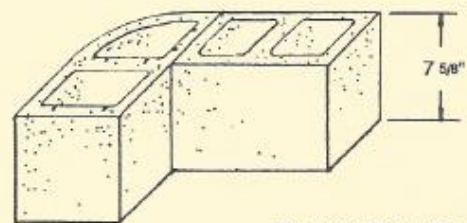
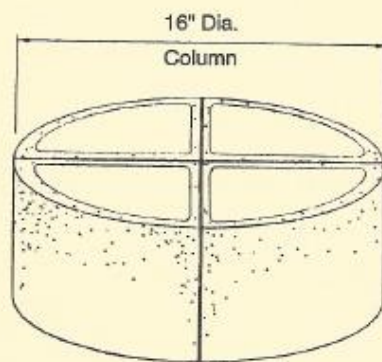
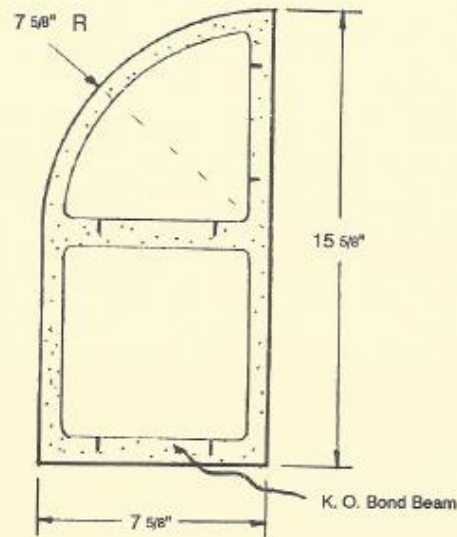

16" Dia. Column from job site cut 8 x 8 x 16 Units

For exact configurations & dimensions of cores please consult your Architectural Representative.

PRECISION RADIUS BLOCK

1' RADIUS

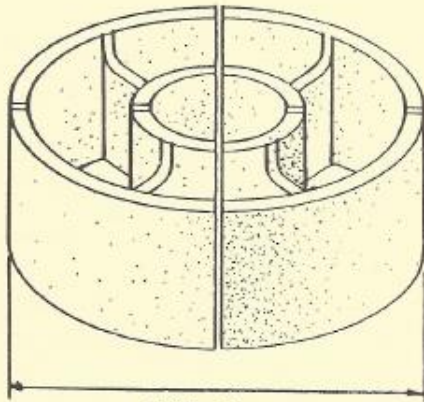
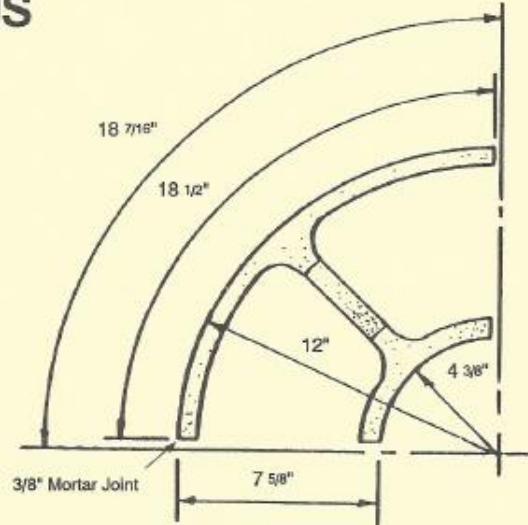

24" Dia. Column
(4 Units)

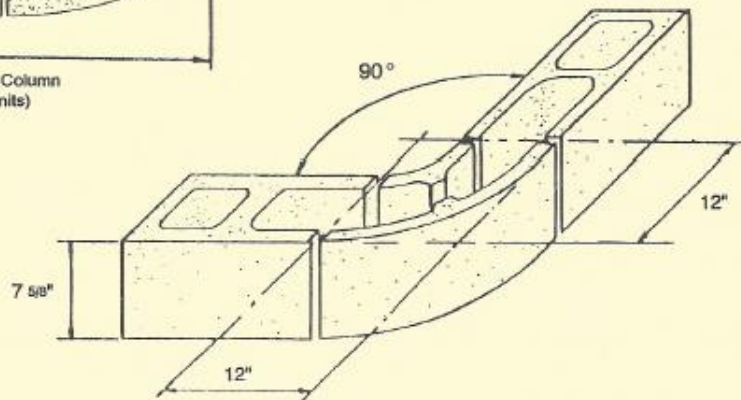

For exact configurations & dimensions of cores please consult your Architectural Representative.

PRECISION RADIUS BLOCK

4' RADIUS

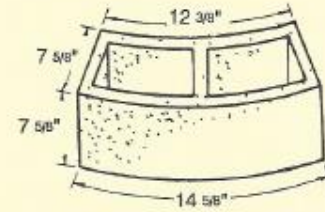
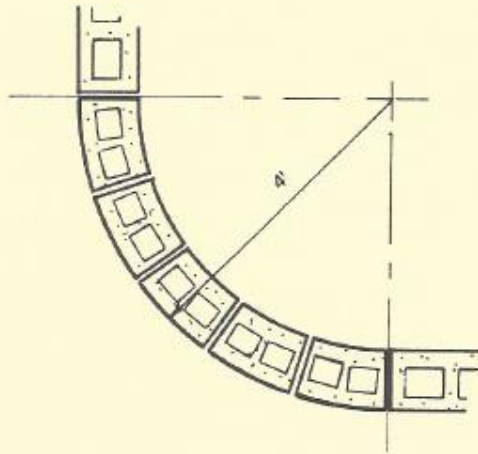

Also available in *505* & Lido scored units.
Twenty Block to a Circle.

2' RADIUS

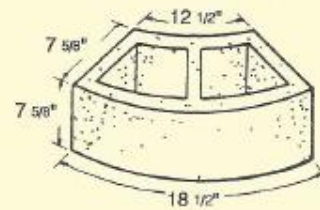
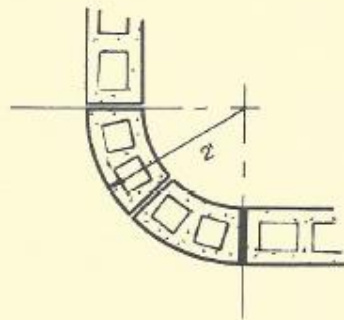

Also available in Lido scored units.
Eight Block to a Circle.

These units are to be used in stack bond only.

For exact configurations & dimensions of cores please consult your Architectural Representative.